

---

# ELECTRIC AND GAS DRYERS

## Use & Care Guide

For questions about features, operation/performance, parts, accessories or service call: **1-800-253-1301**

or visit our website at  
**[www.estateappliances.com](http://www.estateappliances.com)**

---

Table of Contents.....	2
------------------------	---

---

---

# TABLE OF CONTENTS

<b>DRYER SAFETY</b> .....	<b>3</b>
<b>PARTS AND FEATURES</b> .....	<b>5</b>
<b>CHECKING YOUR VENT</b> .....	<b>6</b>
<b>DRYER USE</b> .....	<b>7</b>
Starting Your Dryer.....	7
Stopping and Restarting.....	7
Loading Clothes .....	8
Drying, Cycle, and Temperature Tips .....	8
<b>CYCLE DESCRIPTIONS</b> .....	<b>8</b>
Auto Sense Drying Automatic Cycle.....	8
Timed Dry Cycle.....	9
No Heat Fluff Cycle .....	9
Drying Rack.....	9
<b>DRYER CARE</b> .....	<b>10</b>
Cleaning the Lint Screen.....	10
Cleaning the Dryer Interior .....	10
Removing Accumulated Lint from Inside the Dryer Cabinet.....	10
Changing the Drum Light.....	10
<b>TROUBLESHOOTING</b> .....	<b>11</b>
<b>ASSISTANCE OR SERVICE</b> .....	<b>12</b>
<b>WARRANTY</b> .....	<b>16</b>

# DRYER SAFETY

## Your safety and the safety of others are very important.

We have provided many important safety messages in this manual and on your appliance. Always read and obey all safety messages.



This is the safety alert symbol.

This symbol alerts you to potential hazards that can kill or hurt you and others.

All safety messages will follow the safety alert symbol and either the word "DANGER" or "WARNING." These words mean:

**! DANGER**

You can be killed or seriously injured if you don't immediately follow instructions.

**! WARNING**

You can be killed or seriously injured if you don't follow instructions.

All safety messages will tell you what the potential hazard is, tell you how to reduce the chance of injury, and tell you what can happen if the instructions are not followed.

**WARNING: For your safety, the information in this manual must be followed to minimize the risk of fire or explosion, or to prevent property damage, personal injury, or death.**

- Do not store or use gasoline or other flammable vapors and liquids in the vicinity of this or any other appliance.
- **WHAT TO DO IF YOU SMELL GAS:**
  - Do not try to light any appliance.
  - Do not touch any electrical switch; do not use any phone in your building.
  - Clear the room, building, or area of all occupants.
  - Immediately call your gas supplier from a neighbor's phone. Follow the gas supplier's instructions.
  - If you cannot reach your gas supplier, call the fire department.
- Installation and service must be performed by a qualified installer, service agency, or the gas supplier.

## IMPORTANT SAFETY INSTRUCTIONS

**WARNING:** To reduce the risk of fire, electric shock, or injury to persons when using the dryer, follow basic precautions, including the following:

- Read all instructions before using the dryer.
- Do not place items exposed to cooking oils in your dryer. Items contaminated with cooking oils may contribute to a chemical reaction that could cause a load to catch fire.
- Do not dry articles that have been previously cleaned in, washed in, soaked in, or spotted with gasoline, dry-cleaning solvents, other flammable, or explosive substances as they give off vapors that could ignite or explode.
- Do not allow children to play on or in the dryer. Close supervision of children is necessary when the dryer is used near children.
- Before the dryer is removed from service or discarded, remove the door to the drying compartment.
- Do not reach into the dryer if the drum is moving.
- Do not install or store the dryer where it will be exposed to the weather.
- Do not tamper with controls.
- Do not repair or replace any part of the dryer or attempt any servicing unless specifically recommended in this Use and Care Guide or in published user-repair instructions that you understand and have the skills to carry out.
- Do not use fabric softeners or products to eliminate static unless recommended by the manufacturer of the fabric softener or product.
- Do not use heat to dry articles containing foam rubber or similarly textured rubber-like materials.
- Clean lint screen before or after each load.
- Keep area around the exhaust opening and adjacent surrounding areas free from the accumulation of lint, dust, and dirt.
- The interior of the dryer and exhaust vent should be cleaned periodically by qualified service personnel.
- See Installation Instructions for grounding requirements.

**SAVE THESE INSTRUCTIONS**

# PARTS AND FEATURES

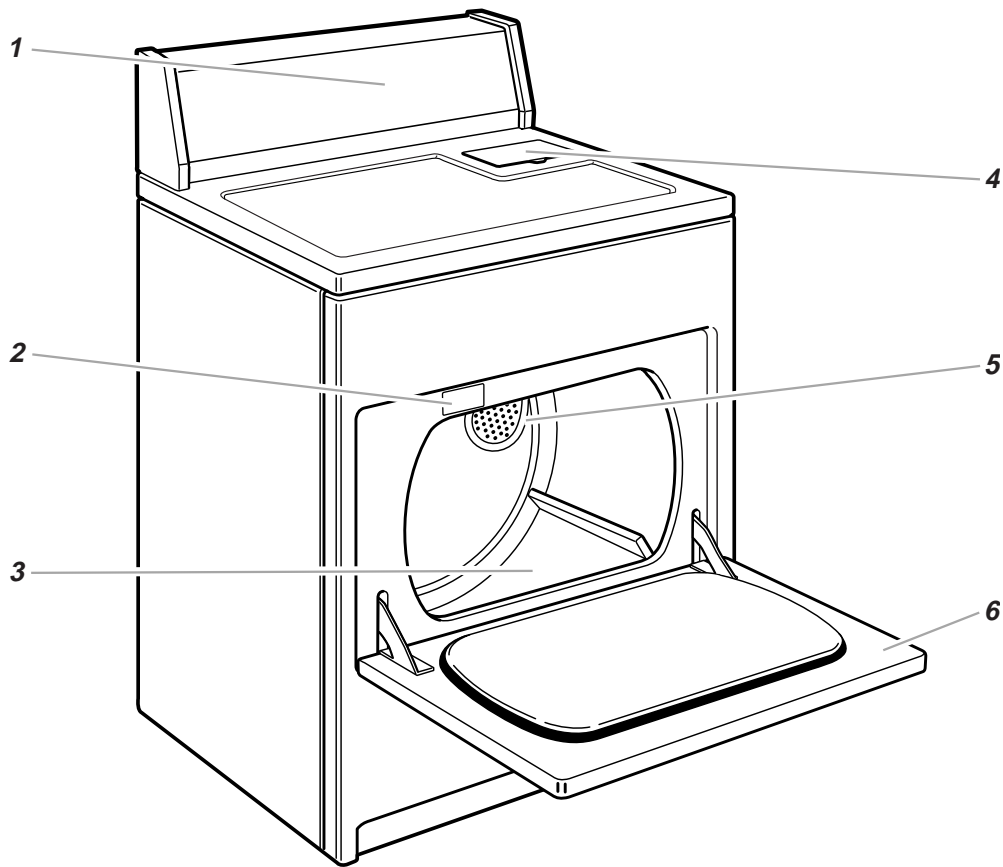

1. Control panel
2. Model and serial number label
3. Dryer drum
4. Lint screen
5. Exhaust grille
6. Wide-opening door\*

## Additional features your dryer may have

- End of Cycle Signal selector
- Drum light
- Temperature selector

## Optional purchase

- Drying rack

## \*Other door type

Large side-swing door

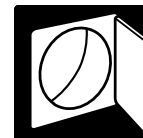

This is a reversible door – See your Installation Instructions.

## Control Panel

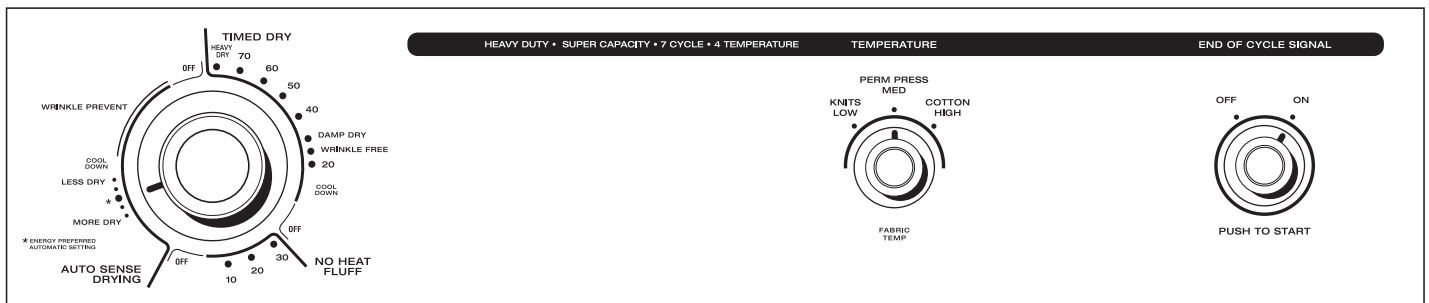

**NOTE:** The drawings in this book may vary from your dryer. They are designed to show all of the models covered by this book. Your dryer may not include all features.

# CHECKING YOUR VENT

Your dryer must be properly installed and vented to achieve maximum drying efficiency and shorten drying times. Use the minimum recommended installation clearances (found in your Installation Instructions) to avoid blocking the flow of combustion and ventilation air. Refer to your Installation Instructions for more information.

## ! WARNING



### Fire Hazard

**Use a heavy metal vent.**

**Do not use a plastic vent.**

**Do not use a metal foil vent.**

**Failure to follow these instructions can result in death or fire.**

If the dryer is not properly installed and vented, it will not be covered under the warranty.

**NOTE:** Service calls caused by improper venting will be paid for by the customer, whether it was a paid installation or self-installed.

- Do not** use plastic vent or metal foil vent. Use 4 in. (10.2 cm) metal or flexible metal vent. Do not kink or crush flexible metal vent. It must be completely extended to allow adequate exhaust air to flow. Check vent after installation. Refer to your Installation Instructions for proper length requirements of vent.

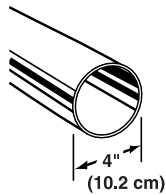

- Use a 4 in. (10.2 cm) exhaust hood. Smaller hoods increase drying times.

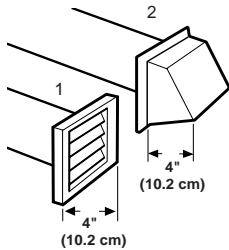

- The exhaust vent can be routed up, down, left, right, or straight out the back of the dryer. Space requirements are listed in your Installation Instructions.

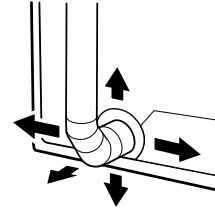

- Use the straightest path possible when routing the exhaust vent. Use the fewest number of elbows and turns. Allow room when using elbows or making turns. Bend vent gradually to avoid kinking.

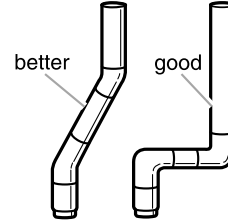

- Use duct tape to seal all joints. **Do not** use screws to secure vent. Lint may catch on screws.

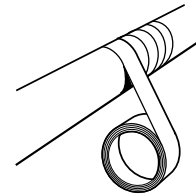

- Clean exhaust vent periodically, depending on use, but at least every 2 years, or when installing your dryer in a new location.

- Disconnect vent from the dryer and clean one section at a time until you reach the exhaust hood.

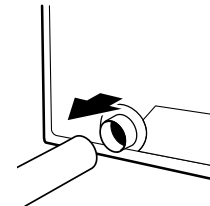

- To clean out lint, use the hose attachment on your vacuum, or a pole or wire with a feather duster or rag attached.
- Be sure the flapper on the outside end of vent moves freely.
- When cleaning is complete, be sure to follow the Installation Instructions supplied with your dryer for final product check.

# DRYER USE

## Starting Your Dryer

### ⚠️ WARNING



#### Explosion Hazard

Keep flammable materials and vapors, such as gasoline, away from dryer.

Do not dry anything that has ever had anything flammable on it (even after washing).

Failure to follow these instructions can result in death, explosion, or fire.

### ⚠️ WARNING



#### Fire Hazard

No washer can completely remove oil.

Do not dry anything that has ever had any type of oil on it (including cooking oils).

Items containing foam, rubber, or plastic must be dried on a clothesline or by using an Air Cycle.

Failure to follow these instructions can result in death or fire.

Before using your dryer, wipe the dryer drum with a damp cloth to remove dust from storing and shipping.

1. Load clothes loosely into the dryer and close the door. Do not pack the dryer. Allow space for clothes to tumble freely.



2. Turn the Cycle Control knob to the recommended cycle for the type of load being dried. Use the Energy Preferred Automatic Setting (\*) to dry most heavyweight and medium weight loads. See “Drying, Cycle and Temperature Tips.”

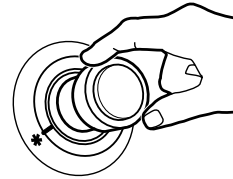

3. Select a temperature setting on models with a Temp/Fabric selector. The cycle descriptions include temperature setting suggestions.  
**NOTE:** The temperature selector is part of the Cycle Control knob on some models.
4. Select the End of Cycle Signal, if available. The signal is helpful when drying permanent press or synthetics. Promptly remove these items from the dryer at the end of the cycle to prevent wrinkles.  
On some models the End of Cycle Signal is part of the START button. Turn the START button to ON or OFF.
5. Push the START button.

## Stopping and Restarting

You can stop your dryer any time during a cycle.

### To stop your dryer

Open the dryer door or turn the Cycle Control knob to OFF.

**NOTE:** The Cycle Control knob should point to an Off area when the dryer is not in use.

### To restart your dryer

1. Close the door.
2. Select a new cycle and temperature (if desired).
3. Push START.

## Loading Clothes

Load clothes loosely into the dryer. Do not pack the dryer. Allow space for clothes to tumble freely. The following chart shows examples of balanced loads that would allow for proper tumbling.

<b>Heavy work clothes</b>	3 pair of pants, 4 pair of jeans, 2 pair of overalls, 3 shirts
<b>Delicates</b>	3 camisoles, 1 robe, 4 slips, 6 undergarments, 2 sets of sleepwear, 1 child's outfit
<b>Towels</b>	10 bath towels, 10 hand towels, 14 wash cloths, 1 bath mat
<b>Mixed Load</b>	3 double sheets, 4 pillowcases, 8 T-shirts, 6 pair of shorts, 2 blouses, 8 handkerchiefs

## Drying, Cycle, and Temperature Tips

Select the correct cycle and temperature for your load.

Cool Down tumbles the load without heat during the last few minutes of all cycles to make the load easier to handle.

### Drying tips

- Follow care label directions when they are available.
- If you use fabric softener sheets, use only those labeled "dryer safe." Follow package instructions.
- Remove the load from the dryer as soon as tumbling stops, to reduce wrinkling. This is especially important for permanent press, knits, and synthetic fabrics.

### Cycle and temperature tips

- Dry most loads using the Energy Preferred Automatic Setting (\*), if available on your dryer.
- Use a High heat setting for drying heavyweight items such as towels and work clothes.
- Use a Medium heat setting for drying medium weight items, such as sheets, underwear, permanent press fabrics, and some knits.
- Use a Low heat setting for drying lightweight items such as lingerie, blouses, dresses, and some knits.
- Use a no-heat (air) setting for rubber, plastic, or heat-sensitive fabrics.
- Line dry bonded or laminated fabrics.

**NOTE:** If you have questions about drying temperatures for various loads, refer to the care label directions. If you are unsure of the temperature to select for a load, select a lower setting rather than a higher setting.

## CYCLE DESCRIPTIONS

This manual covers several different models. Your dryer may vary from the model shown and may not have all of the cycles and features described.

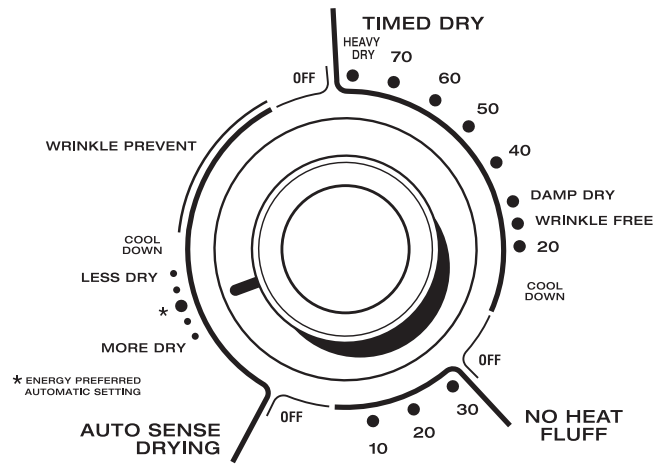

Cycle Control knob

## Auto Sense Drying Automatic Cycle

Use this cycle to dry most loads. Your dryer uses an automatic control that senses the moisture in the load and shuts off the dryer when the selected dryness is reached. The Cycle Control knob does not move until the load is almost dry. After the cool down, the knob automatically turns to an Off area and tumbling stops.

Dry most loads using the Energy Preferred Automatic Setting (\*).

- If the load is drier than you like, select a setting closer to LESS DRY the next time you dry a similar load.
- If the load is not as dry as you like, complete drying using the Timed Dry cycle. The next time you dry a similar load, select a setting closer to VERY DRY or MORE DRY.

**NOTE:** Drying time with an automatic cycle varies according to the type of fabric, size of load, and temperature setting. See "Drying, Cycle and Temperature Tips."

### WRINKLE PREVENT feature

When you are unable to remove a load from the dryer as soon as it stops, wrinkles can form. The WRINKLE PREVENT feature periodically tumbles, rearranges and fluffs the load without heat up to 45 minutes after the cycle ends to avoid wrinkling. This feature is automatic and activates at the end of the cycle, if you do not open the dryer door within a few minutes after the cycle ends.

### Towels

Select this cycle to thoroughly dry extra heavy items such as mattress pads and quilts or a load of towels. Set the temperature selector to High heat.



## Timed Dry Cycle

Use this cycle to complete drying if items are still damp after the automatic cycle.

Timed Dry is also useful for:

- Heavyweight and bulky items, such as bedspreads and work clothes and large loads that require a long drying time. Set the Temperature selector, if available, to High heat or to a setting that matches the care label directions.
- Lightweight items, such as lingerie, blouses, and knits that require a short drying time. Set the Temperature selector if available, to Low heat.

**NOTE:** on some models, temperature is included in the cycle selections. Drying time and temperature will depend on your dryer model.

### Heavy Dry

Select this setting to evenly dry large or heavy items, such as thick cotton bath towels or robes. Set the Temperature selector, if available, to High heat.

### Damp Dry

Select this setting to dry items to a damp level or dry items that do not require an entire drying cycle. Damp dry items such as jeans (to prevent stiffness) or cotton clothes (to make pressing easier). Set the Temperature selector, if available, to High heat.

### Wrinkle Free

Use this setting to remove wrinkles from items, such as clothes packed in a suitcase or items wrinkled from being left in the dryer too long. Set the Temperature selector, if available, at Low heat or Medium heat, depending on the fabrics in your load.

## No Heat Fluff Cycle

Use this cycle for items that require drying without heat, such as rubber, plastic and heat-sensitive fabrics. See the chart for examples of items that can be dried using an air cycle.

Type of Load	Cycle Time*
Foam rubber - pillows, padded bras, stuffed toys	20 - 30
Plastic - shower curtains, tablecloths	20 - 30
Rubber-backed rugs	40 - 50
Olefin, polypropylene, sheer nylon	10 - 20

\*(Minutes). Reset cycle to complete drying, if needed.

### When using an air cycle

- Check to see that coverings are securely stitched.
- Shake and fluff pillows by hand periodically during cycle.
- Dry item completely. Foam rubber pillows are slow to dry.

## Drying Rack

The drying rack is useful for machine drying items you would not necessarily want to tumble dry or that you would normally line dry (for example, sweaters, pillows, stuffed toys).

If your model does not have a drying rack, you may purchase one. For ordering information, please refer to the "Assistance or Service" page of this manual. You may also contact the dealer from whom you purchased your dryer.

### To use the drying rack

1. Slide rear pegs into the dimples on the back wall of the dryer. Lower the front legs to rest on the dryer opening.

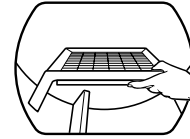

2. Put the wet items on top of the rack. Leave space between the items so air can reach all the surfaces. Close the door.
 

**NOTE:** Do not allow items to hang over the edge of the rack.

3. Select a timed drying cycle and temperature, or an air cycle. Items containing foam, rubber, or plastic must be dried on a clothesline or by using an air cycle.

4. Push the START button.

**NOTE:** The rack must be removed for normal tumbling. Do not use the automatic cycle with the drying rack.

This chart shows examples of items that can be rack-dried and the suggested cycle, temperature setting, and drying time. Actual drying time will depend on the amount of moisture items hold.

Rack Dry	Cycle	Temp	Time*
<b>Wool Sweaters</b> Block to shape and lay flat on the rack	Timed	Low	60
<b>Stuffed toys or pillows</b> Cotton or polyester fiber filled	Timed	Low	60
<b>Stuffed toys or pillows</b> Foam rubber filled	Air (no heat)	None	90
<b>Sneakers or canvas shoes</b>	Air (no heat)	None	90

\*(Minutes). Reset cycle to complete drying, if needed.

# DRYER CARE

## Cleaning the Lint Screen

### Every load cleaning

The lint screen is located on the top of the dryer. Clean it before each load. A screen blocked by lint can increase drying time.

### To clean

1. Pull the lint screen towards you. Roll lint off the screen with your fingers. Do not rinse or wash screen to remove lint. Wet lint is hard to remove.

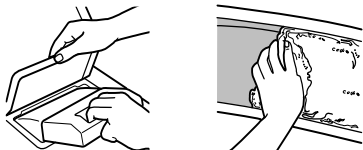

2. Push the lint screen firmly back into place.

### IMPORTANT:

- Do not run the dryer with the lint screen loose, damaged, blocked, or missing. Doing so can cause overheating and damage to both the dryer and fabrics.
- Some towels made of synthetic fibers and natural fibers (polyester and cotton blends) may shed more lint than other towels, causing your dryer's lint screen to fill up faster. Be sure to remove lint from the lint screen before and after drying new towels.
- If lint falls off the screen into the dryer during removal, check the exhaust hood and remove the lint. See "Checking Your Vent."

### As needed cleaning

Laundry detergent and fabric softener residue can build up on the lint screen. This buildup can cause longer drying times for your clothes, or cause the dryer to stop before your load is completely dry. The screen is probably clogged if lint falls off the screen.

Clean the lint screen with a nylon brush every six months, or more frequently if it becomes clogged due to a residue buildup.

### To wash

1. Wet both sides of lint screen with hot water.
2. Wet a nylon brush with hot water and liquid detergent. Scrub lint screen with the brush to remove residue buildup.

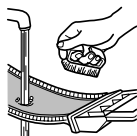

3. Rinse screen with hot water.
4. **Thoroughly** dry lint screen with a clean towel. Insert lint screen back into dryer.

## Cleaning the Dryer Interior

### **! WARNING**



### Explosion Hazard

**Use nonflammable cleaner.**

**Failure to do so can result in death, explosion, or fire.**

### To clean dryer drum

1. Make a paste with powdered laundry detergent and very warm water.
2. Apply paste to a soft cloth.

### OR

Apply a liquid, non-flammable household cleaner to the stained area and rub with a soft cloth until all excess dye is removed.

3. Wipe drum thoroughly with a damp cloth.
4. Tumble a load of clean cloths or towels to dry drum.

**NOTE:** Garments which contain unstable dyes, such as denim blue jeans or brightly colored cotton items, may discolor the dryer interior. These stains are not harmful to your dryer and will not stain future loads of clothes. Dry unstable dye items inside-out to prevent dye transfer.

## Removing Accumulated Lint from Inside the Dryer Cabinet

Lint should be removed every two years, or more often, depending on dryer usage. Cleaning should be done by a qualified person.

## Changing the Drum Light

The dryer light automatically turns on inside the dryer drum when you open the door.

### To change the drum light

1. Unplug dryer or disconnect power.
2. Open the dryer door. Locate the light bulb cover on the back wall of the dryer. Remove the screw located in the lower right corner of the cover. Remove the cover.

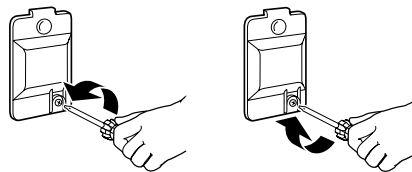

3. Turn bulb counterclockwise. Replace the bulb only with a 10-watt appliance bulb. Replace the cover and secure with the screw.
4. Plug in dryer or reconnect power.

---

# TROUBLESHOOTING

First try the solutions suggested here and possibly avoid the cost of a service call...

---

## Clothes are not drying satisfactorily

---

- **Check the following:**

Is the lint screen clogged with lint?

Is the exhaust vent or outside exhaust hood clogged with lint, restricting air movement? Run the dryer for 5-10 minutes. Hold your hand under the outside exhaust hood to check air movement. If you do not feel air movement, clean exhaust system of lint or replace exhaust vent with heavy metal or flexible metal vent. See your Installation Instructions.

Is the exhaust vent crushed or kinked? Replace with heavy metal or flexible metal vent. See your Installation Instructions.

Has a fuse blown, or a circuit breaker tripped? Electric dryers use 2 household fuses or breakers. The drum may be turning, but you may not have heat.

Has an air dry cycle been selected? Select the right cycle for the types of garments being dried. See "Drying, Cycle and Temperature Tips."

For gas dryers, is the valve open on the supply line?

Are fabric softener sheets blocking the grille? Use only one fabric softener sheet, and use it only once.

- **Is the dryer located in a room with temperature below 45°F (7°C)?**

Proper operation of dryer cycles requires temperatures above 45°F (7°C).

- **Was a cold rinse water used? Was the load very wet?**

Expect longer drying times with items rinsed in cold water and with items that hold moisture (cottons).

- **Is the load too large and heavy to dry quickly?**

Separate the load to tumble freely.

---

## Dryer will not run

---

- **Check the following:**

Is the power cord plugged in?

Has a fuse blown, or has a circuit breaker tripped?

Was a regular fuse used? Use a time-delay fuse.

Is the dryer door firmly closed?

Was the START button firmly pressed?

Is a cycle selected?

---

---

## Unusual sounds

---

- **Has the dryer had a period of non-use?**

If the dryer hasn't been used for a while, there may be a thumping sound during the first few minutes of operation.

- **Is it a gas dryer?**

The gas valve clicking is a normal operating sound.

---

## Lint on load

---

- **Is the lint screen clogged?**

Clean lint screen. Check for air movement.

- **Is the load properly sorted?**

Sort lint givers (towels, chenille) from lint takers (corduroy, synthetics). Also sort by color.

- **Is the load too big or too heavy?**

Dry smaller loads so lint can be carried to the lint screen.

- **Was the load overdried?**

Use correct dryer settings for load type. Overdrying can cause lint-attracting static electricity. See "Drying, Cycle, and Temperature Tips."

- **Was paper or tissue left in pockets?**

Clean out pockets before drying.

- **Is pilling being mistaken for lint?**

Pilling (surface fuzz) is caused by normal wear and laundering.

---

## Stains on load or color change

---

- **Was dryer fabric softener properly used?**

Add dryer fabric softener sheets at the beginning of the cycle. Fabric softener sheets added to a partially-dried load can stain your garments.

- **Were items soiled when placed in the dryer?**

Items should be clean before being dried.

- **Were items properly sorted?**

Sort light colors from dark colors. Sort colorfast items from noncolorfast items.

---

## Items shrinking

---

- **Was the dryer overloaded?**

Dry smaller loads that will tumble freely.

- **Did the load overdry?**

Check the manufacturer's care label. Match dryer setting to load type. See "Drying, Cycle, and Temperature Tips."

---

---

## Loads are wrinkled

---

- **Was the load removed from dryer at the end of the cycle?**  
Remove load as soon as tumbling stops.
- **Was the dryer overloaded?**  
Dry smaller loads that can tumble freely.
- **Did the load overdry?**  
Check the manufacturer's care label. Match dryer setting to load type. See "Drying, Cycle, and Temperature Tips."

---

## Odors

---

- **Have you recently been painting, staining or varnishing in the area where your dryer is located?**  
If so, ventilate the area. When the odors or fumes are gone from the area, re-wash and dry the clothing.
- **If the dryer is electric, is it being used for the first time?**  
The new electric heating element may have an odor. The odor will be gone after the first cycle.
- **If the dryer is gas, there may be a gas leak.**  
Turn off the gas supply line, leave your house, and then call your local gas company.

---

## Garment damage

---

- **Check the following:**  
Were zippers, snaps, and hooks left open?  
Were strings and sashes tied to prevent tangling?  
Were care label instructions followed?  
Were items damaged before drying?

---

# ASSISTANCE OR SERVICE

Before calling for assistance or service, please check "Troubleshooting." It may save you the cost of a service call. If you still need help, follow the instructions below.

When calling, please know the purchase date and the complete model and serial number of your appliance. This information will help us to better respond to your request.

### If you need replacement parts

If you need to order replacement parts, we recommend that you only use FSP® factory specified parts. These parts will fit right and work right, because they are made with the same precision used to build every new ESTATE® appliance. To locate FSP replacement parts in your area call our Customer Interaction Center or your nearest designated service center.

### For assistance or service

Call the Customer Interaction Center toll free at **1-800-253-1301**.

### Our consultants provide assistance with:

- Features and specifications on our full line of appliances
- Installation information
- Use and maintenance procedures
- Accessory and repair parts sales
- Specialized customer assistance (Spanish speaking, hearing impaired, limited vision, etc.)
- Referrals to local dealers, repair parts distributors, and service companies.

Estate designated service technicians are trained to fulfill the product warranty and provide after-warranty service, anywhere in the United States.

To locate the Estate designated service company in your area, you can also look in your telephone directory Yellow Pages.

### For further assistance

If you need further assistance, you can write with any questions or concerns at:

Estate Brand Home Appliances  
Customer Interaction Center  
553 Benson Road  
Benton Harbor, MI 49022-2692

Please include a daytime phone number in your correspondence.

### Accessories U.S.A.

To order accessories, call the Whirlpool Customer Interaction Center toll free at **1-800-442-9991** and follow the menu prompts. Or visit our website at **www.estateappliances.com** and click on "Buy Accessories Online."

---

# ESTATE® DRYER WARRANTY

---

## ONE-YEAR FULL WARRANTY

For one year from the date of purchase, when this dryer is operated and maintained according to instructions attached to or furnished with the product, Whirlpool Corporation will pay for FSP® replacement parts and repair labor to correct defects in materials or workmanship. Service must be provided by a Whirlpool designated service company.

---

### Whirlpool Corporation will not pay for:

1. Service calls to correct the installation of your dryer, including venting. Heavy 4 in (10.2 cm) metal exhaust vent must be used. Refer to the venting section of this manual and your Installation Instructions.
  2. Service calls to instruct you how to use your dryer, to replace house fuses or correct house wiring or reset circuit breakers, or to replace owner accessible light bulbs.
  3. Repairs when your dryer is used in other than normal, single-family household use.
  4. Damage resulting from accident, alteration, misuse, abuse, fire, floods, acts of God, improper installation (including, but not limited to, venting with plastic or flexible foil), installation not in accordance with local electrical and plumbing codes, or use of products not approved by Whirlpool Corporation.
  5. Replacement parts or repair labor costs for units operated outside the United States.
  6. Pickup and delivery. This product is designed to be repaired in the home.
  7. Repairs to parts or systems resulting from unauthorized modifications made to the appliance.
- 

### WHIRLPOOL CORPORATION SHALL NOT BE LIABLE FOR INCIDENTAL OR CONSEQUENTIAL DAMAGES.

Some states do not allow the exclusion or limitation of incidental or consequential damages, so this exclusion or limitation may not apply to you. This warranty gives you specific legal rights and you may also have other rights which vary from state to state.

### Outside the 50 United States, this warranty does not apply. Contact your authorized Estate dealer to determine if another warranty applies.

If you need service, first see the "Troubleshooting" section of this book. Additional help can be found by checking the "Assistance or Service" section or by calling the Customer Interaction Center toll free at **1-800-253-1301** from anywhere in the U.S.A. or write: Estate Brand Home Appliances, Customer Interaction Center, 553 Benson Road, Benton Harbor, MI 49022-2692.

4/00

---

### Keep this book and your sales slip together for future reference. You must provide proof of purchase or installation date for in-warranty service.

Write down the following information about your dryer to better help you obtain assistance or service if you ever need it. You will need to know your complete model number and serial number. You can find this information on the model and serial number label/plate, located on your appliance as shown in "Parts and Features."

Dealer name \_\_\_\_\_  
Address \_\_\_\_\_  
Phone number \_\_\_\_\_  
Model number \_\_\_\_\_  
Serial number \_\_\_\_\_  
Purchase date \_\_\_\_\_